



VACUFLEX

CONDUCTOS DE EVACUACIÓN



TARIFA2023



Compañía con más de 30 años de experiencia en el suministro de materiales para la evacuación de humos y gases.

Ubicada en Santa Perpètua de Mogoda (Barcelona), VACUFLEX cuenta con un equipo comprometido para ofrecer un servicio basado en el asesoramiento personalizado, la calidad y profesionalidad.

Asimismo, dispone de una amplia gama de fumistería en stock para garantizar una entrega rápida y eficaz.



**C/ Guifré el Pilòs, 3 – P.I. Can Vinyals
08130 – Santa Perpètua de Mogoda (Barcelona)
Tel. 93 464 32 33 – Fax 93 464 36 37
info@vacuflex.es
www.vacuflex.es**

Índice General

Gama

CONDENSACIÓN

Pág. 6

Sistema Simple: Fabricado en polipropileno PP
Diámetro $\varnothing 80$

Sistema Coaxial: Fabricado en polipropileno PP/Aluminio
Diámetro $\varnothing 60/100\text{mm}$
 $\varnothing 80/125\text{mm}$

Aplicaciones:

Conductos para la evacuación de humos y gases en calderas de condensación.



Gama

ALU-VAC

Pág. 16

Fabricado en aluminio con recubrimiento en esmalte de poliuretano.

Diámetros desde $\varnothing 80$ a $\varnothing 130$

Aplicaciones:

Conductos para la evacuación de humos y gases en aparatos atmosféricos y estancos en sistema biflujo.



Fabricado en aluminio con recubrimiento en esmalte de poliuretano.

Diámetros: $\varnothing 60/100\text{mm}$
 $\varnothing 80/110\text{mm}$
 $\varnothing 80/125\text{mm}$

Aplicaciones:

Conductos de aluminio para la evacuación de gases de calderas estancas.



Fabricado en polipropileno plástico blanco. Rejillas en chapa de acero con recubrimiento en esmalte de poliuretano o aluminio pulido.

Diámetros: $\varnothing 100$ - $\varnothing 120$ - $\varnothing 150$

Aplicaciones:

Extracción de humos y gases en campanas extractoras, ventilación mecánica y aerotermia.



Aplicaciones



Iconos empleados en la tarifa según aplicación de cada gama

Gama

CONDENSACIÓN

Sistema de conexión de calderas de condensación

SISTEMA SIMPLE

▪ Polipropileno PP

▪ Diámetros:

ø80mm (hasta
ø250mm bajo pedido)



T120-H1-O-W-2-0(30)-I-E-L

T120-P1-O-W-2-0(10)-I-C-L/L0



Productos conformes con las normativas EN 14471:2005, homologado CE y certificado

APLICACIONES



CARACTERÍSTICAS

- Conductos para la evacuación de humos y gases en calderas de condensación
- Junta de EPDM resistente hasta 140°C
- Sistema de unión Macho-Hembra

SISTEMA COAXIAL

- Polipropileno
PP/Aluminio
- Diámetros:
Ø60/100mm
Ø80/125mm



T120-P1-O-W-1-O(00)-E-E-L0
T120-H1-W-1/2-O(00)-LE-E-UO

APLICACIONES



CE Productos conformes con las normativas
EN 14471:2005 y 14471:2013+A1:2015,
homologado CE y certificado

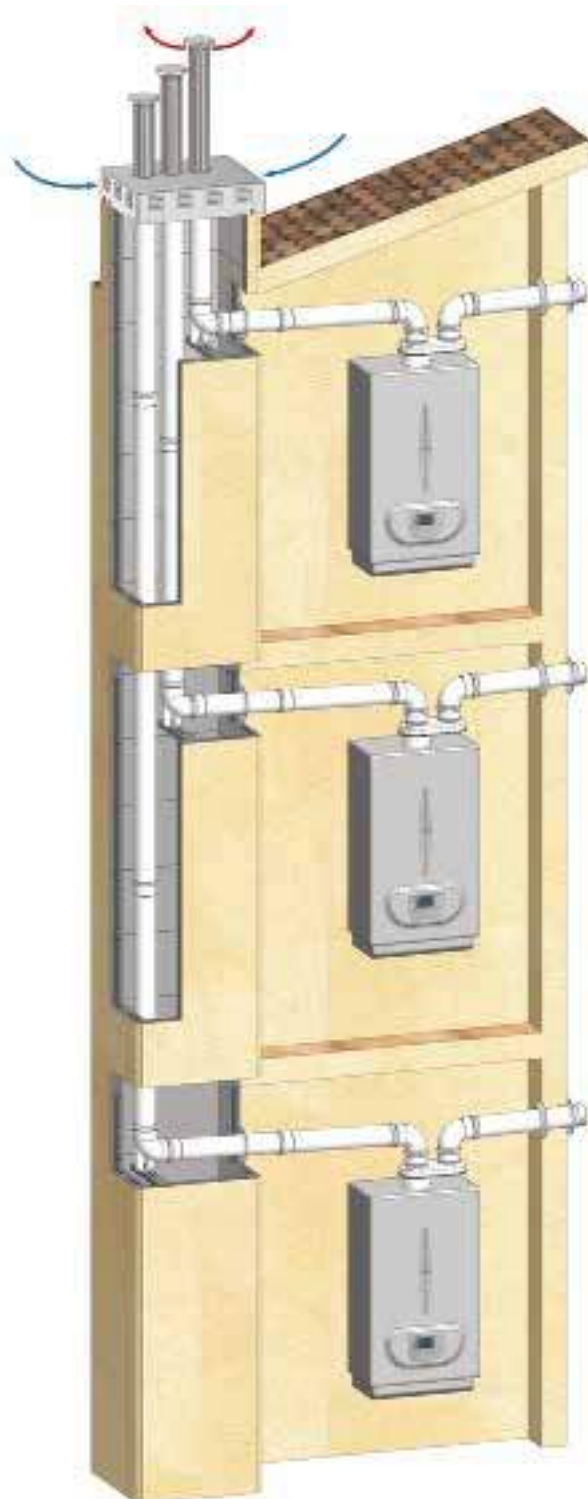

Sistema colectivo SIMPLE

Ejemplo de aparato de condensación en una instalación colectiva biflujo simple.



Sistema múltiple COAXIAL

Ejemplo de aparato de condensación en una instalación colectiva con tubos concéntricos $\varnothing 60-100\text{mm}$.

TUBOS			Ø80
	Tubo 250mm	Ref.	60.800.250
		€	
		u/caja	1
	Tubo 500mm	Ref.	60.800.500
		€	
		u/caja	1
	Tubo 1000mm	Ref.	60.800.000
		€	
		u/caja	1
	Tubo 2000mm	Ref.	60.800.020
		€	
		u/caja	1

CODOS Y TES			Ø80
	Codo 45°	Ref.	60.800.045
		€	
		u/caja	1
	Codo 90°	Ref.	60.800.090
		€	
		u/caja	1
	Te 90°	Ref.	60.800.109
		€	
		u/caja	1

ABRAZADERAS			Ø80
	Abrazadera fijación pared	Ref.	92.191.002
		€	
		u/caja	6

DEFLECTORES			Ø80
	Tubo Deflector INOX	Ref.	60.800.300
		€	
		u/caja	1

			Ø80
	Tubo Deflector horizontal 500mm M-M	Ref.	60.800.302
		€	
		u/caja	1



SEPARADOR MONOBLOQUE BIFLUJO		Ø80	
	SIME - BIASI - FERROLI - JOANNES - SAVIO - RADIANT	Ref.	60D06D80
		€	
		u/caja	1
	Compatibilidad		
	ARGO - BAXI - REMEHA - VISSMANN - ROTEX	Ref.	
€			
u/caja		1	
Compatibilidad			
ARISTON - BERETTA - CHAFFOTEAUX - YGNIS - ATLANTIC - ECOFLAM - RIELLO - IGNIS - VAILLANT	Ref.	60D08D80	
	€		
	u/caja	1	
Compatibilidad			
SAUNIER DUVAL - HERMANN - ATON	Ref.	60D09D80	
	€		
	u/caja	1	
Compatibilidad			
JUNKERS - BOSCH	Ref.	60D10D80	
	€		
	u/caja	1	
Compatibilidad			

Junta EPDM incluida

SISTEMA SIMPLE FLEXIBLE		Ø80	
	Rollo tubo flexible	Ref.	60.800.001 60.800.002
		€	
		m/caja	10 m 50 m
		Junta EPDM no incluida	

JUNTA EPDM		Ø60	Ø80	Ø100	Ø125	
	Junta EPDM	Ref.	60.800.006	60.800.007	60.800.008	60.800.009
	Para tubo flexible de Ø80 y recambios	€				
		u/caja	1	1	1	1

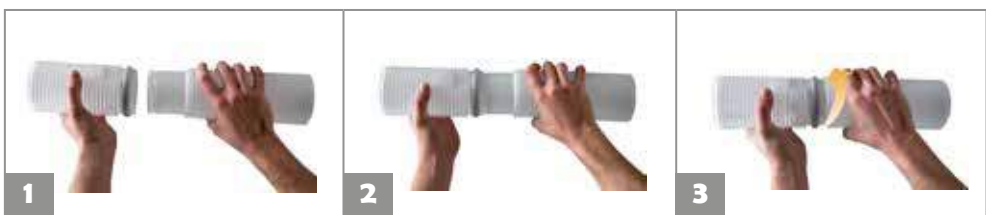

• Cada metro incluye 1 macho y 3 hembras (máximo aprovechamiento)

TUBOS			Ø60/100	Ø80/125
	Tubo 200mm	Ref.	60.810.200	60.811.200
		€		
		u/caja	6	6
	Tubo 500mm	Ref.	60.810.500	60.811.500
		€		
		u/caja	6	6
Tubo 1000mm	Ref.	60.810.000	60.811.000	
	€			
	u/caja	1	1	
Tubo 2000mm	Ref.	60.810.020	60.811.020	
	€			
	u/caja	6	6	



CODOS			Ø60/100	Ø80/125
	Codo 45°	Ref.	60.810.045	60.811.045
		€		
		u/caja	1	1
	Codo 90°	Ref.	60.810.090	60.811.090
		€		
		u/caja	1	1

ABRAZADERAS			Ø60/100	Ø80/125
	Abrazadera fijación pared	Ref.	92.192.002	92.194.002
		€		
		u/caja	6	6
	Abrazadera pared circular	Ref.	92.192.003	92.194.003
		€		
		u/caja	6	6

DEFLECTORES		Ø60/100	Ø80/125
Deflector Condensación Coaxial	Ref.	60.810.310	60.811.310
	€		
	u/caja	1	1



		Ø60/100	Ø80/125
Tubo Deflector Horizontal M-M	Ref.	60.810.300	60.811.300
	€		
	u/caja	1	1



		Ø60/100	Ø80/125
Deflector Vertical Cubreaguas Negro (inclinación 20°/50°)	Ref.	60.810.350	60.811.350
	€		
	u/caja	1	1



		Ø60/100	Ø80/125
Deflector Vertical Negro 0,5 metros	Ref.	60.810.400	60.811.400
	€		
	u/caja	1	1

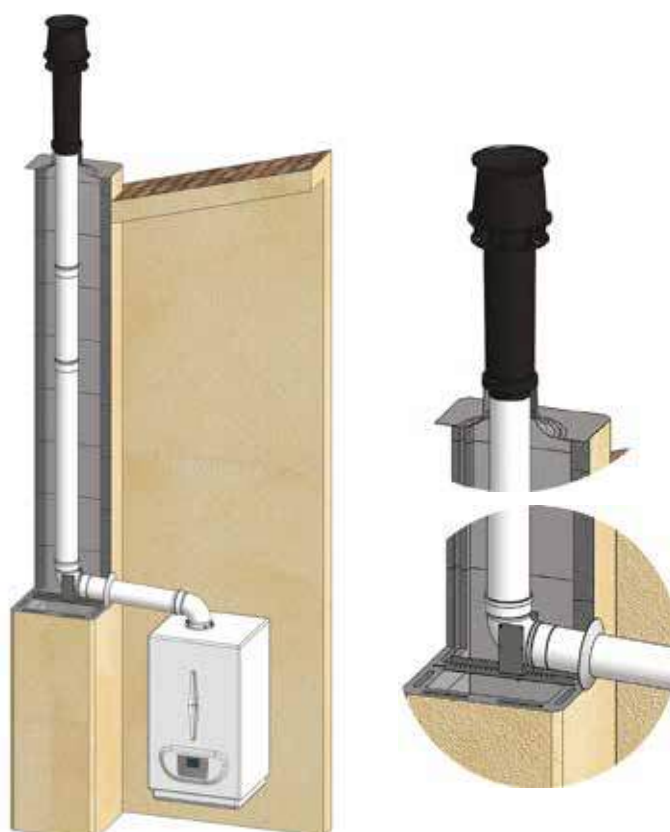

Salida a tejado

Ejemplo de instalación con salida vertical en sistema coaxial.

KIT CONDENSACIÓN COAXIAL M/H			Ø60/100
	SIME - ITHALTERM - BALTUR - ARIFEL	Ref.	60PACKIT1
	Compatibilidad	€	
		u/caja	1
	ARISTON - BERETTA - CHAFFOTEAUX - YGNIS - ATLANTIC - ECOFLAM - RIELLO - IGNIS - VAILLANT - RHEMM RADI - SYLBER	Ref.	60PACKIT2
	Compatibilidad	€	
		u/caja	1
	ARGO - BAXI - REMEHA - VISSMANN - ROTEX - ROCA	Ref.	60PACKIT3
	Compatibilidad	€	
		u/caja	1
	BIASI - FERROLI - FONDITAL - LAMBORGHINI - NOVA - FLORIDA - SAVIO UNICAL - JOANNES	Ref.	60PACKIT4
	Compatibilidad	€	
		u/caja	1
	SAUNIER DUVAL - HERMANN - ATON	Ref.	60PACKIT5
	Compatibilidad	€	
		u/caja	1
	IMMERGAS	Ref.	60PACKIT6
	Compatibilidad	€	
		u/caja	1
	JUNKERS - BOSCH	Ref.	60PACKIT7
	Compatibilidad	€	
		u/caja	1

Lacado en blanco RAL 9003 - Juntas incluidas

ADAPTADOR CONDENSACIÓN COAXIAL M/H			Ø60/100
	Adaptador condensación coaxial M-H Ø60/100 A Ø80/125	Ref.	60.610.825
		€	
		u/caja	1

SALIDA VERTICAL CONDENSACIÓN COAXIAL M/H		\varnothing 60/100
	Ref.	60PACPV01
	€	
	u/caja	1
	Ref.	60PACPV02
	€	
	u/caja	1
	Ref.	60PACPV03
	€	
	u/caja	1
	Ref.	60PACPV04
	€	
	u/caja	1
	Ref.	60PACPV05
	€	
	u/caja	1
	Ref.	60PACPV06
	€	
	u/caja	1

Lacado en blanco RAL 9003 - Juntas incluidas

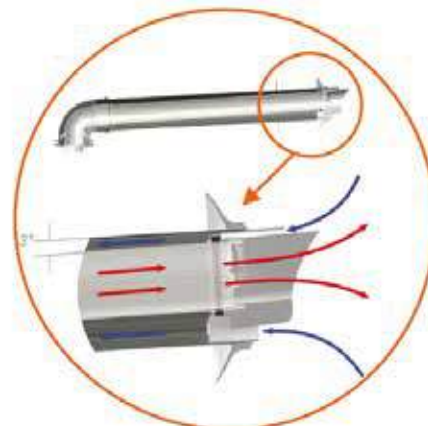

Salida a pared

Ejemplo salida horizontal en muro.

Gama

ALU-VAC

Conductos para la evacuación de gases en aparatos atmosféricos y estancos en sistema biflujo



EN 1856-2 T200 N1 W Vm L13100 O



CARACTERÍSTICAS

- Fabricado en aluminio liso rígido con recubrimiento en blanco de esmalte de poliuretano
- Diámetros desde $\varnothing 80\text{mm}$ a $\varnothing 130\text{mm}$
- Estanqueidad mediante unión con junta de silicona (incluida en el precio)
- Sistema de unión: Macho-Macho
- Temperatura de trabajo: 200°C (intervalos a 250°C)

APLICACIONES







CERTIFICACIONES





- Productos conformes con las normativas RIGLO, RITE, UNE EN 1856-2, homologado CE y certificado
- Producto certificado por TÜV



TUBOS LISOS			$\varnothing 80$	$\varnothing 100$	$\varnothing 110$	$\varnothing 125$	$\varnothing 130$
	Tubo liso 200mm	Ref.	92.191.200	92.192.200	92.193.200	92.194.200	92.195.200
		€					
		u/caja	6	6	6	6	6
	Tubo liso 500mm	Ref.	92.191.500	92.192.500	92.193.500	92.194.500	92.195.500
		€					
		u/caja	6	6	6	6	6
	Tubo liso 1000mm	Ref.	92.191.000	92.192.000	92.193.000	92.194.000	92.195.000
		€					
		u/caja	6	6	6	6	6
	Tubo liso 1500mm	Ref.	92.191.015	92.192.015	92.193.015	92.194.015	92.195.015
		€					
		u/caja	6	6	6	6	6
	Tubo 200mm con toma de muestras	Ref.		92.192.202	92.193.202	92.194.202	
		€					
		u/caja		6	6	6	

CODOS Y TES			$\varnothing 80$	$\varnothing 100$	$\varnothing 110$	$\varnothing 125$	$\varnothing 130$
	Codo 45°	Ref.	92.191.045	92.192.045	92.193.045	92.194.045	92.195.045
		€					
		u/caja	6	6	6	6	6
	Codo 90°	Ref.	92.191.090	92.192.090	92.193.090	92.194.090	92.195.090
		€					
		u/caja	6	6	6	6	6

MÓDULOS FINALES			$\varnothing 80$	$\varnothing 100$	$\varnothing 110$	$\varnothing 125$	$\varnothing 130$
	Deflector 3 aros	Ref.	92.191.010	92.192.010	92.193.010	92.194.010	92.195.010
		€					
		u/caja	6	6	6	6	6
	Deflector antiretorno	Ref.	92.191.011	92.192.011	92.193.011		92.195.011
		€					
		u/caja	6	6	6		6

ABRAZADERAS			\varnothing 80	\varnothing 100	\varnothing 110	\varnothing 125	\varnothing 130
	Abrazadera fijación pared regulable	Ref.	92.191.002	92.192.002	92.193.002	92.194.002	92.195.002
		€					
		u/caja	6	6	6	6	6
	Abrazadera fijación pared circular	Ref.		92.192.003	92.193.003	92.194.003	92.195.003
		€					
		u/caja		6	6	6	6
	Abrazadera fijación estática	Ref.			93.341.003*		
		€					
		u/caja			6		

* Disponible hasta agotar existencias; una vez liquidado el stock, la referencia quedará descatalogada.

ADAPTADORES			\varnothing 80	\varnothing 100	\varnothing 110	\varnothing 125	\varnothing 130
	Adaptador para ampliación	Ref.	92.191.160	92.192.160	92.193.160	92.194.160	
		€					
		u/caja	6 \varnothing 100	6 \varnothing 110	6 \varnothing 125	6 \varnothing 130	
	Adaptador caldera con toma muestras 200mm	Ref.		92.192.161	92.193.161	92.194.161	
		€					
		u/caja		6 \varnothing 103	6 \varnothing 115	6 \varnothing 128	
	Manguito unión tubo con juntas	Ref.	92.191.001	92.192.001	92.193.001	92.194.001	92.195.001
		€					
		u/caja	6	6	6	6	6

ACCESORIOS			\varnothing 80	\varnothing 100	\varnothing 110	\varnothing 125	\varnothing 130
	Embellecedor metálico	Ref.	87.197.140P*	92.192.140	92.193.140	92.194.140	92.195.140
		€					
		u/caja	6	6	6	6	6
	Junta silicona bilabial	Ref.	92.191.180	92.192.180	92.193.180	92.194.180	92.195.180
		€					
		u/caja	6	6	6	6	6

* Embellecedor \varnothing 80 fabricado en plástico

Gama

ESTANCA COAXIAL

**Conductos de aluminio para la evacuación de gases
en calderas estancas**



EN 1856-2 T200 N1 W Vm L13100 O
EN 1856-2 T200 P1 W Vm L13100 O



CARACTERÍSTICAS

- Fabricada en aluminio y chapa de acero laminada en frío con recubrimiento en esmalte poliuretano
- Sistema de unión Macho-Hembra
- Diámetros $\varnothing 60-100\text{mm}$
 $\varnothing 80-110\text{mm}$
 $\varnothing 80-125\text{mm}$
- Temperatura de trabajo: 200°C
(intervalos a 250°C)

APLICACIONES



CERTIFICACIONES



- Productos conformes con las normativas RIGLO, RITE, UNE 1856-2, homologado CE y certificado
- Producto certificado por TÜV

TUBOS PROLONGADORES			Ø60/100	Ø80/110	Ø80/125
	Tubo prolongador 250mm M/H	Ref.	81.372.250	81.377.250	81.382.250
		€			
		u/caja	6	6	6
	Tubo prolongador 500mm M/H	Ref.	81.372.500	81.377.500	81.382.500
		€			
		u/caja	6	6	6
	Tubo prolongador 1000mm M/H	Ref.	81.372.000	81.377.000	81.382.000
		€			
		u/caja	1	1	1
	Tubo prolongador 1500mm M/H	Ref.	81.372.015	81.377.015	81.382.015
		€			
		u/caja	6	6	6

CODOS			Ø60/100	Ø80/110	Ø80/125
	Codo Coaxial 45° M/H	Ref.	81.373.045	81.378.045	81.383.045
		€			
		u/caja	1	1	1
	Codo Coaxial 90° M/H	Ref.	81.373.090	81.378.090	81.383.090
		€			
		u/caja	1	1	1

ADAPTADOR			Ø60/100	Ø80/110	Ø80/125
	Adaptador para ampliación Ø60/100 a Ø80/125 M/H	Ref.	81.372.160		
		€			
		u/caja	1		

MANGUITO			Ø60/100	Ø80/110	Ø80/125
	Manguito Coaxial unión tubos H/H	Ref.	64.370.001	64.375.001	64.380.001
		€			
		u/caja	6	6	6

TERMINAL			Ø60/100	Ø80/110	Ø80/125
	Deflector Coaxial Aluminio	Ref.	81.372.010	64.375.010	81.382.010
		€			
		u/caja	6	6	6

Salida horizontal

Ejemplo de calentador estanco con salida coaxial a pared.

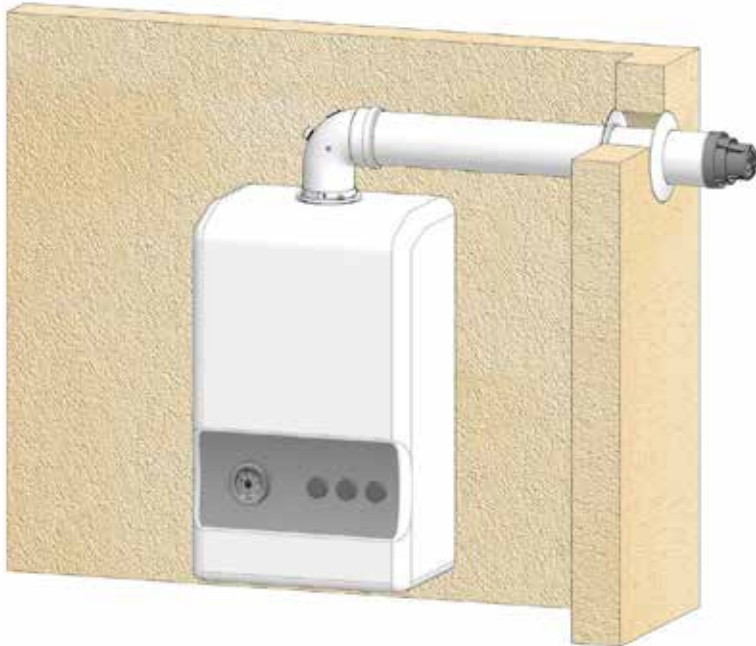

Salida vertical

Ejemplo de calentador estanco con salida coaxial vertical a tejado.

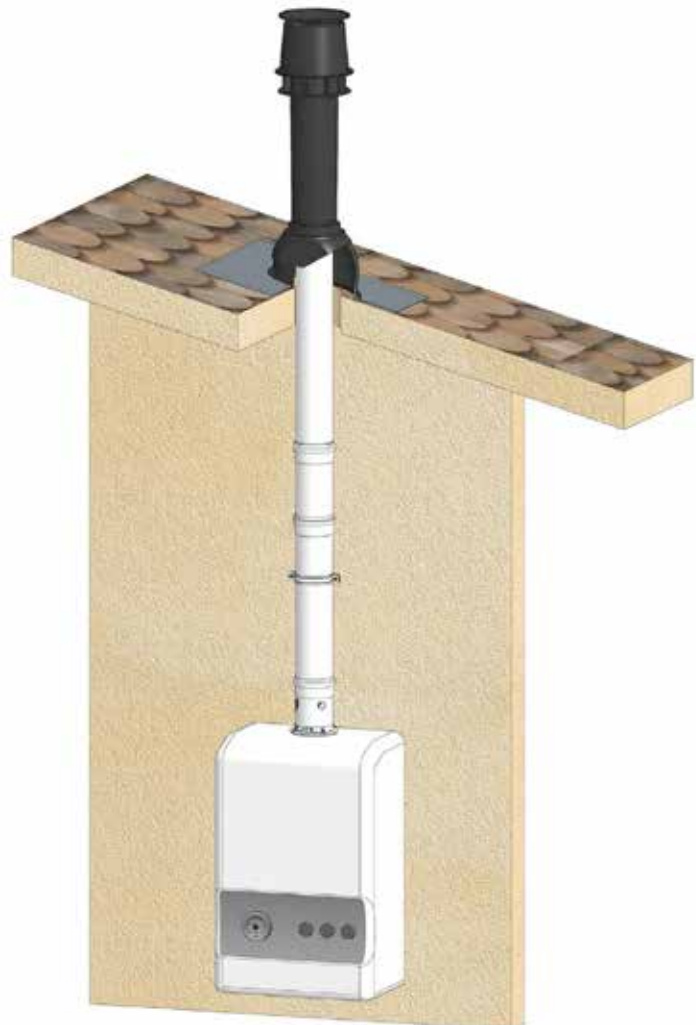

Gama

VENTILACIÓN y AIREACIÓN

Sistemas de extracción de humos y gases en
campanas extractoras y ventilación mecánica

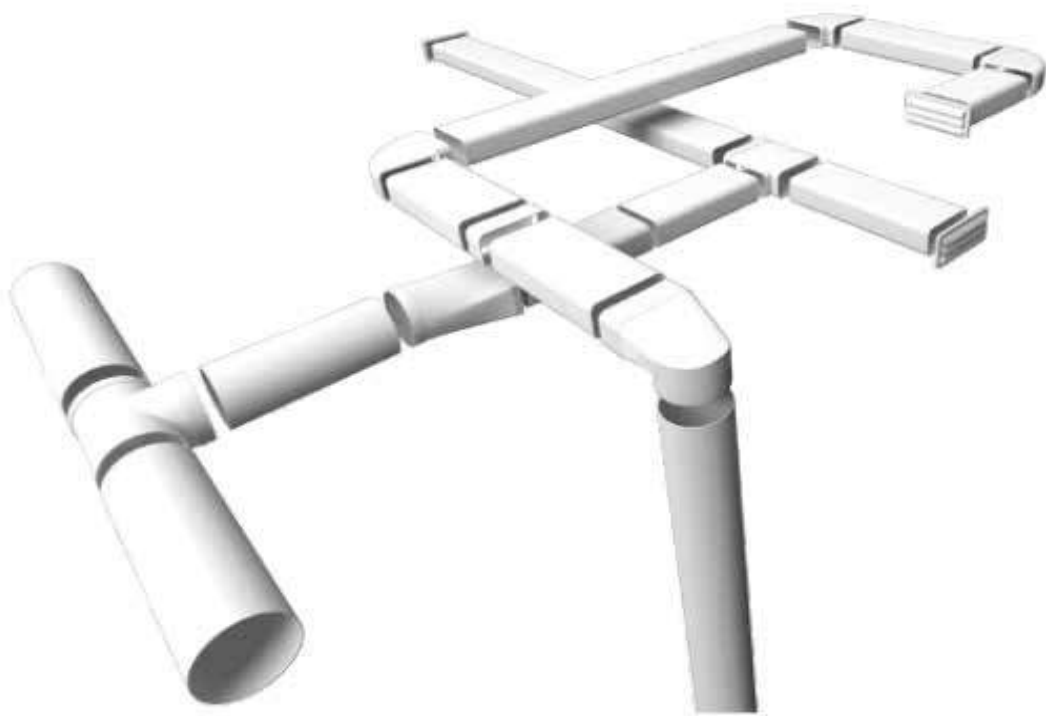

CARACTERÍSTICAS

- Polipropileno plástico
- Diámetros $\varnothing 100$ - $\varnothing 120$ - $\varnothing 150$
- Resistencia a temperaturas de hasta 90°C
- Aplicación: Extracción, campanas extractoras, ventilación y aerotermia

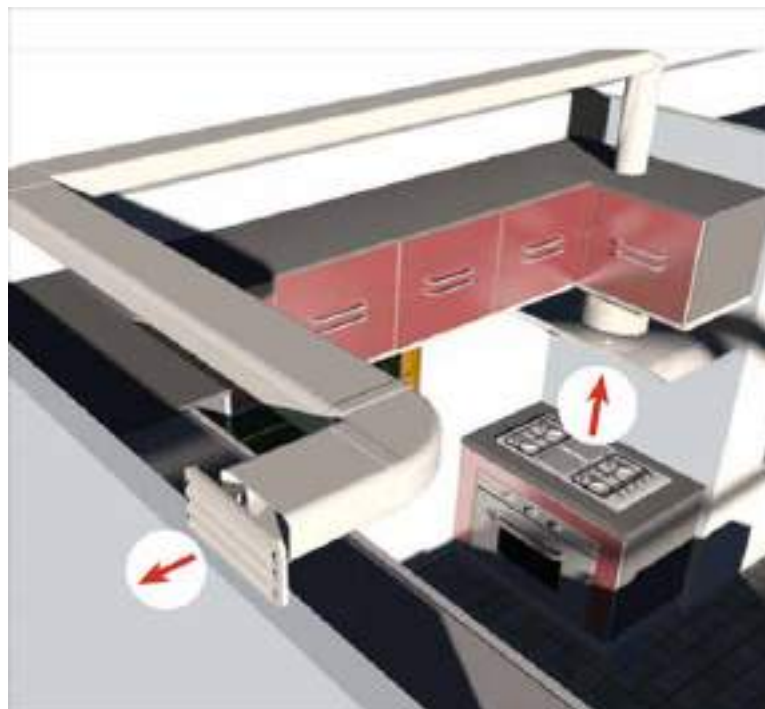

Ignífugo y autoextinguible

Higiénico y antibacteriano

Alta estanqueidad

Atenuador acústico

Atérmico y dieléctrico

Anti-adherente

APLICACIONES



VENTILACIÓN

Sistemas de extracción de humos y gases en campanas extractoras y ventilación mecánica



Ø100 - Ø120 - Ø150mm

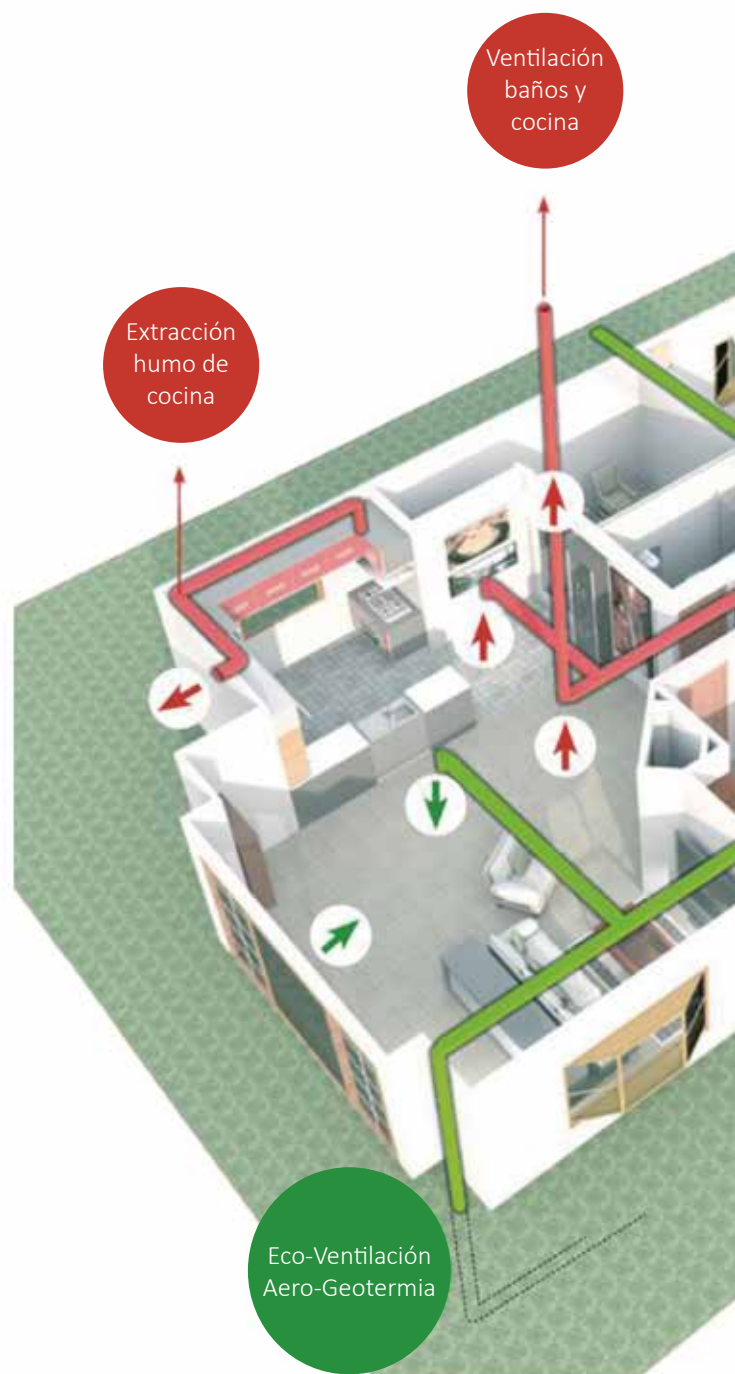





Muestras de aplicaciones

- Sistema de extracción de humos en cocinas
- Ventilación de baño, aseos y zonas húmedas
- Ventilación terciaria de locales y oficinas
- Eco-Ventilación y Geo-Ventilación
- Ventilación natural, híbrida y mecánica

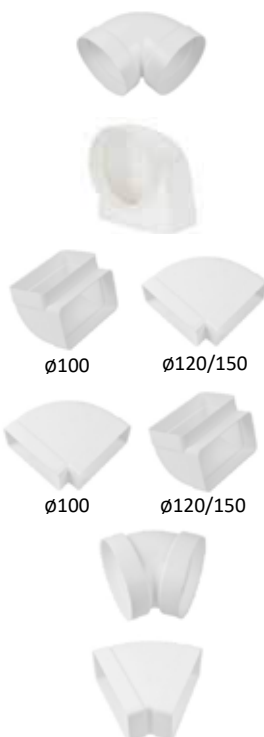
TUBOS			Ø100 110 X 56 mm	Ø120 147 X 70 mm	Ø150 170 X 90 mm
	Tubo rectangular 2 metros	Ref.	80.000.101		
		€			
		u/caja	6		
	Tubo rectangular 1,5 metros	Ref.	63.100.200	63.120.000	63.130.000
		€			
		u/caja	16	12	8
Tubo redondo 2 metros	Ref.	80.000.110			
	€				
	u/caja	6			
Tubo redondo 1,5 metros	Ref.	63.100.201	63.120.101	63.130.101	
	€				
	u/caja	12	8	8	

CODOS			Ø100 110 X 56 mm	Ø120 147 X 70 mm	Ø150 170 X 90 mm
	Codo 90° redondo	Ref.	80.000.113E	63.120.106	63.130.106
		€			
		u/caja	45	30	15
	Codo 90° mixto	Ref.	80.000.107E	63.120.107	63.130.107
		€			
		u/caja	60	30	15
	Codo 90° rectangular horizontal	Ref.	80.000.103E	63.120.109	63.130.109
		€			
		u/caja	105	30	15
	Codo 90° rectangular vertical	Ref.	80.000.108E	63.120.108	63.130.108
		€			
		u/caja	72	30	15
	Codo 45° redondo	Ref.	63.100.223	63.120.123	
		€			
		u/caja	50	30	
Codo 45° rectangular horizontal	Ref.	63.100.218	63.120.118	63.130.118	
	€				
	u/caja	50	30	15	

EMPALMES			Ø100 110 X 56 mm	Ø120 147 X 70 mm	Ø150 170 X 90 mm
	Empalme rectangular	Ref.	80.000.104E	63.120.104	63.130.104
		€			
		u/caja	60	30	15
	Empalme redondo	Ref.	80.000.111E	63.120.102	63.130.102
		€			
		u/caja	60	30	15
	Empalme pared mixto	Ref.	80.000.105E		
		€			
		u/caja	80		
	Empalme mixto	Ref.	80.000.106E	63.120.105	63.130.105
		€			
		u/caja	45	30	15
	Empalme pared redondo	Ref.		63.120.121	
		€			
		u/caja		30	
	Empalme pared rectangular	Ref.		63.120.122	
		€			
		u/caja		30	

ABRAZADERAS			Ø100 110 X 56 mm	Ø120 147 X 70 mm	Ø150 170 X 90 mm
	Abrazadera fijación pared rectangular horizontal metálica	Ref.	80.000.109		
		€			
		u/caja	50		
	Abrazadera fijación pared rectangular vertical metálica	Ref.	80.000.114		
		€			
		u/caja	50		
	Abrazadera fijación pared redonda metálica	Ref.	92.192.003		
		€			
		u/caja	6		
	Abrazadera redonda PVC	Ref.		63.120.115	
		€			
		u/caja		30	
	Abrazadera rectangular plana PVC	Ref.		63.120.116	
		€			
		u/caja		30	

ADAPTADORES CAMPANA						
	Adaptador campana salida Ø96 Ø100 Ø116 Ø120 Ø124	Ref.	80.000.112	Adaptador campana Ø125 a Ø120	Ref.	63.120.125
		€			€	
		u/caja	60		u/caja	30
	Adaptador campana salida Ø125 a Ø100	Ref.	63.120.103	Adaptador campana Ø150 a Ø120	Ref.	63.120.154
		€			€	
		u/caja	30		u/caja	30

EMBELLECEDORES		Ø120 147 X 70 mm			
	Embelledor pared redondo	Ref.	63.120.113	63.120.114	Ref.
		€			€
		u/caja	30	30	u/caja
	Embelledor pared rectangular				

VENTANAS REJILLAS			Ø100 110 X 56 mm	Ø120 147 X 70 mm	Ø150 170 X 90 mm
	Ventana rejilla redonda	Ref.	80.000.102E	63.120.124	
		€			
		u/caja	60	30	
	Ventana rejilla rectangular	Ref.	80.000.115	63.120.126	
		€			
		u/caja	60	30	
	Ventanilla salida exterior redonda	Ref.		63.120.110	
		€			
		u/caja		30	
	Ventanilla salida exterior rectangular	Ref.		63.120.111	
		€			
		u/caja		30	
	Ventanilla mixta (antiretorno)	Ref.			63.130.110
		€			
		u/caja			15
	Ventanilla mixta marrón (antiretorno)	Ref.			63.130.150
		€			
		u/caja			15
	Rejilla exterior rectangular marrón			63.120.152	
	Rejilla exterior redonda marrón			63.120.153	

REJILLAS para la ventilación de humos y aire de locales domésticos, comerciales e industriales. La línea aireación se presenta en material de **aluminio y chapa de acero con/sin esmaltado en blanco**. Montaje sencillo y eficaz.

REJILLAS	Paso de aire cm ²	Aluminio	Blanco	Ref.
 Rejilla plana 100 x 100	225 cm ²	88.130.109	88.132.109	Ref.
				€
		100	100	u/caja
 Rejilla plana 150 x 150	60 cm ²	88.130.101	88.132.101	Ref.
				€
		100	100	u/caja
 Rejilla plana 170 x 170	150 cm ²	88.130.102	88.132.102	Ref.
				€
		100	100	u/caja
 Rejilla plana 200 x 200	95 cm ²	88.130.103	88.132.103	Ref.
				€
		100	100	u/caja
 Rejilla plana 300 x 300	240 cm ²	88.130.111	88.132.111	Ref.
				€
		100	100	u/caja
 Rejilla plana 150 x 300	160 cm ²	88.130.104	88.132.104	Ref.
				€
		100	100	u/caja
 Rejilla plana 100 x 200 Horizontal	80 cm ²	88.130.113	88.132.114	Ref.
				€
		100	100	u/caja
 Rejilla plana 200 x 100 Vertical	75 cm ²	88.130.110	88.132.110	Ref.
				€
		100	100	u/caja

Material disponible en stock y en cualquier cantidad

	PVP	u/caja		PVP	u/caja
Rejilla 100x100 Aluminio Madera		200	Rejilla 170x170 Aluminio Blanco con Mosquitera		25
Rejilla 100x200 Aluminio Madera		200	Rejilla 170x170 Aluminio Madera con Mosquitera		25
Rejilla 200x100 Aluminio Madera		200	Rejilla 200x200 Aluminio Madera		100
Rejilla 150x150 Aluminio Madera		250	Rejilla 200x200 Aluminio con Mosquitera		25
Rejilla 150x150 Aluminio con Mosquitera		25	Rejilla 200x200 Esmaltada con Mosquitera		25
Rejilla 150x150 Esmaltada con Mosquitera		25	Rejilla 200x200 Aluminio Blanco con Mosquitera		25
Rejilla 150x150 Aluminio Blanco con Mosquitera		25	Rejilla 200x200 Aluminio Madera con Mosquitera		25
Rejilla 150x150 Aluminio Madera con Mosquitera		25	Rejilla 200x200 Empotrar Aluminio		80
Rejilla 160x160 Empotrar Aluminio		100	Rejilla 200x200 Empotrar Aluminio Blanco		80
Rejilla 160x160 Empotrar Aluminio Blanco		100	Rejilla 200x200 Empotrar Aluminio Madera		80
Rejilla 160x160 Empotrar Aluminio Madera		100	Rejilla 300x150 Aluminio Madera		150
Rejilla 170x170 Aluminio Madera		100	Rejilla 120x240 Empotrar Aluminio		80
Rejilla 170x170 Aluminio con Mosquitera		25	Rejilla 120x240 Empotrar Aluminio Blanco		80

Material disponible bajo pedido y en cajas completas

Condiciones Generales



Estas condiciones corresponden a la presente Tarifa que sustituye y anula todas las anteriores. VACUFLEX se reserva el derecho a introducir modificaciones sin previo aviso, sobre todo en este último periodo de inestabilidad en el mercado de las materias primas.

- Pedido mínimo: 100€
- Portes: se suministrarán a portes pagados los envíos superiores a 400€ de venta neta.
- Devoluciones: en ningún caso se aceptarán devoluciones de material sin la previa autorización de VACUFLEX.
- Reclamaciones: las reclamaciones por incidencias en la recepción de material (diferencias en cantidad o averías) tienen un plazo de reclamación de 48h.
- Uso indebido: cualquier utilización o uso de nuestros productos para fines diferentes a los que fueron fabricados exime a VACUFLEX de cualquier tipo de reclamación o responsabilidad.



Empresa certificada ISO 9001:2015

Certificaciones



Notas



VACUFLEX



C/ Guifré el Pilòs, 3 – P.I. Can Vinyals
08130 – Santa Perpètua de Mogoda (Barcelona)

Tel. 93 464 32 33 – Fax 93 464 36 37

info@vacuflex.es

www.vacuflex.es