



VACUFLEX

# CONDUCTOS DE EVACUACIÓN



Enero  
**TARIFA2024**





*Compañía con más de 30 años de experiencia en el suministro de materiales para la evacuación de humos y gases.*

*Ubicada en Santa Perpètua de Mogoda (Barcelona), VACUFLEX cuenta con un equipo comprometido para ofrecer un servicio basado en el asesoramiento personalizado, la calidad y profesionalidad.*

*Asimismo, dispone de una amplia gama de fumistería en stock para garantizar una entrega rápida y eficaz.*



**C/ Guifré el Pilòs, 3 – P.I. Can Vinyals  
08130 – Santa Perpètua de Mogoda (Barcelona)  
Tel. 93 464 32 33 – Fax 93 464 36 37  
info@vacuflex.es  
www.vacuflex.es**

# Índice General

Gama

## CONDENSACIÓN

Pág. 6

**Sistema Simple:** Fabricado en polipropileno PP  
Diámetro  $\varnothing 80$

**Sistema Coaxial:** Fabricado en polipropileno PP/Aluminio  
Diámetro  $\varnothing 60/100\text{mm}$   
 $\varnothing 80/125\text{mm}$

**Aplicaciones:**

Conductos para la evacuación de humos y gases en calderas de condensación.



Gama

## ALU-VAC

Pág. 16

Fabricado en aluminio con recubrimiento en esmalte de poliuretano.

Diámetros desde  $\varnothing 80$  a  $\varnothing 130$

**Aplicaciones:**

Conductos para la evacuación de humos y gases en aparatos atmosféricos y estancos en sistema biflujo.



Fabricado en aluminio con recubrimiento en esmalte de poliuretano.

Diámetros:  $\varnothing 60/100\text{mm}$   
 $\varnothing 80/110\text{mm}$   
 $\varnothing 80/125\text{mm}$

**Aplicaciones:**

Conductos de aluminio para la evacuación de gases de calderas estancas.



Fabricado en polipropileno plástico blanco. Rejillas en chapa de acero con recubrimiento en esmalte de poliuretano o aluminio pulido.

Diámetros:  $\varnothing 100$  -  $\varnothing 120$  -  $\varnothing 150$

**Aplicaciones:**

Extracción de humos y gases en campanas extractoras, ventilación mecánica y aerotermia.



### Aplicaciones



Iconos empleados en la tarifa según aplicación de cada gama

Gama

# CONDENSACIÓN

Sistema de conexión de calderas de condensación

## SISTEMA SIMPLE

▪ Polipropileno PP

▪ Diámetros:

ø80mm (hasta  
ø250mm bajo pedido)



T120-H1-O-W-2-0(30)-I-E-L

T120-P1-O-W-2-0(10)-I-C-L/L0



Productos conformes con las normativas EN 14471:2005, homologado CE y certificado

## APLICACIONES



## CARACTERÍSTICAS

- Conductos para la evacuación de humos y gases en calderas de condensación
- Junta de EPDM resistente hasta 140°C
- Sistema de unión Macho-Hembra

## SISTEMA COAXIAL

- Polipropileno  
PP/Aluminio
- Diámetros:  
Ø60/100mm  
Ø80/125mm



T120-P1-O-W-1-O(00)-E-E-L0  
T120-H1-W-1/2-O(00)-LE-E-UO

## APLICACIONES



Productos conformes con las normativas  
EN 14471:2005 y 14471:2013+A1:2015,  
homologado CE y certificado

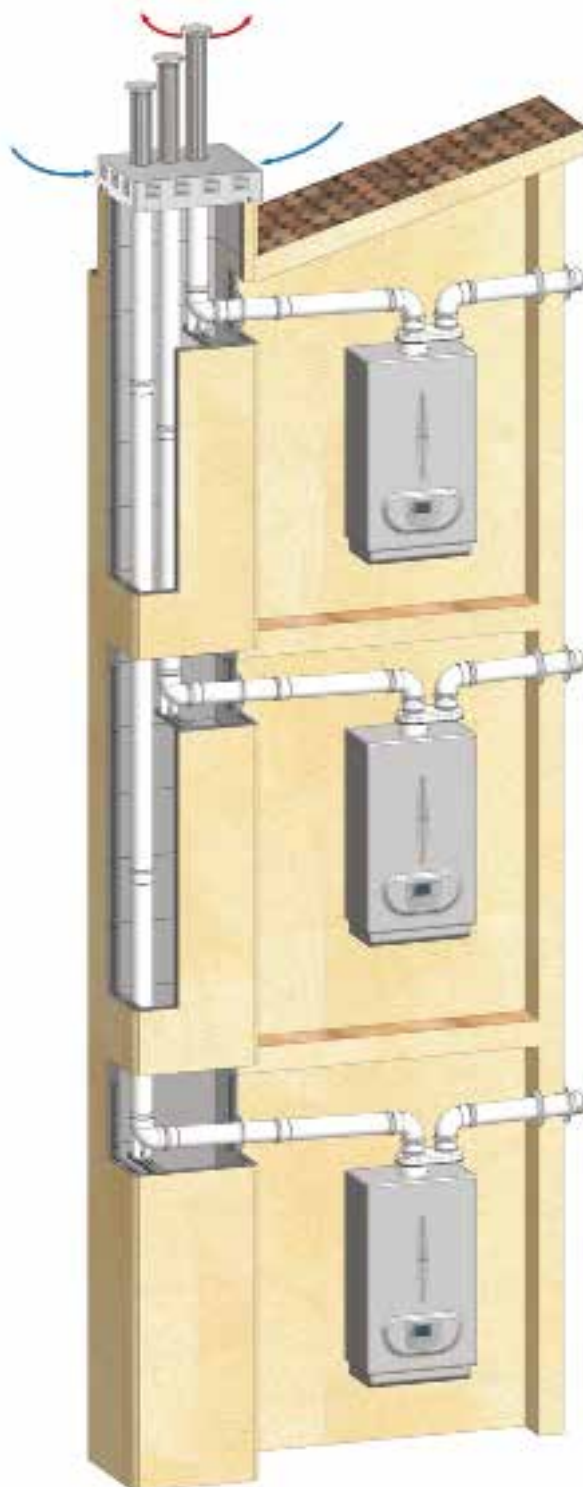

## Sistema colectivo SIMPLE

Ejemplo de aparato de condensación en una instalación colectiva biflujo simple.



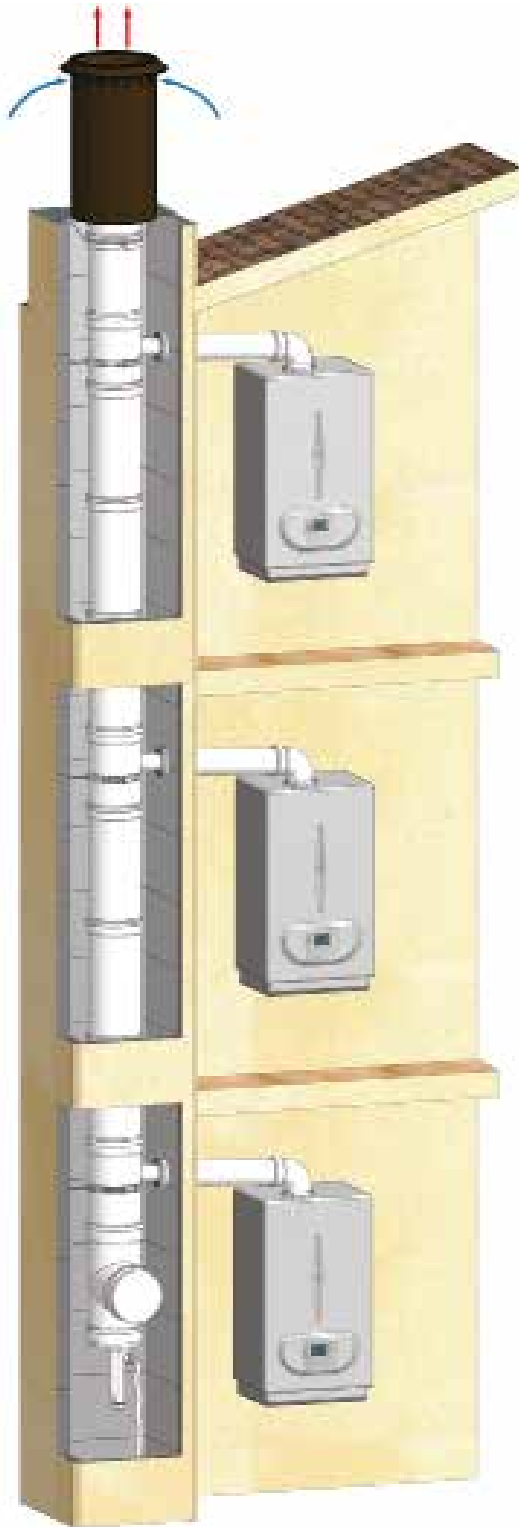

## Sistema múltiple COAXIAL

Ejemplo de aparato de condensación en una instalación colectiva con tubos concéntricos  $\varnothing$ 60-100mm.

TUBOS			Ø80
	<b>Tubo 250mm</b>	Ref.	60.800.250
		€	
		u/caja	1
	<b>Tubo 500mm</b>	Ref.	60.800.500
		€	
		u/caja	1
	<b>Tubo 1000mm</b>	Ref.	60.800.000
		€	
		u/caja	1
	<b>Tubo 2000mm</b>	Ref.	60.800.020
		€	
		u/caja	1

CODOS Y TES			Ø80
	<b>Codo 45°</b>	Ref.	60.800.045
		€	
		u/caja	1
	<b>Codo 90°</b>	Ref.	60.800.090
		€	
		u/caja	1
	<b>Te 90°</b>	Ref.	60.800.109
		€	
		u/caja	1

ABRAZADERAS			Ø80
	<b>Abrazadera fijación pared</b>	Ref.	92.191.002
		€	
		u/caja	6

DEFLECTORES			Ø80
	<b>Tubo Deflector INOX</b>	Ref.	60.800.300
		€	
		u/caja	1

			Ø80
	<b>Tubo Deflector horizontal 500mm M-M</b>	Ref.	60.800.302
		€	
		u/caja	1



SEPARADOR MONOBLOQUE BIFLUJO		Ø80	
	<b>SIME - BIASI - FERROLI - JOANNES - SAVIO - RADIANT</b>	Ref.	60D06D80
		€	
		u/caja	1
	<b>Compatibilidad</b>		
	<b>ARGO - BAXI - REMEHA - VISSMANN - ROTEX</b>	Ref.	60D07D80
€			
u/caja		1	
<b>Compatibilidad</b>			
<b>ARISTON - BERETTA - CHAFFOTEAUX - YGNIS - ATLANTIC - ECOFLAM - RIELLO - IGNIS - VAILLANT</b>	Ref.	60D08D80	
	€		
	u/caja	1	
<b>Compatibilidad</b>			
<b>SAUNIER DUVAL - HERMANN - ATON</b>	Ref.	60D09D80	
	€		
	u/caja	1	
<b>Compatibilidad</b>			
<b>JUNKERS - BOSCH</b>	Ref.	60D10D80	
	€		
	u/caja	1	
<b>Compatibilidad</b>			

Junta EPDM incluida

SISTEMA SIMPLE FLEXIBLE		Ø80	
	<b>Rollo tubo flexible</b>	Ref.	60.800.001    60.800.002
		€	
		m/caja	10 m    50 m
<b>Junta EPDM no incluida</b>			

JUNTA EPDM		Ø60	Ø80	Ø100	Ø125	
	<b>Junta EPDM</b>	Ref.	60.800.006	60.800.007	60.800.008	60.800.009
	<b>Para tubo flexible de Ø80 y recambios</b>	€				
		u/caja	1	1	1	1

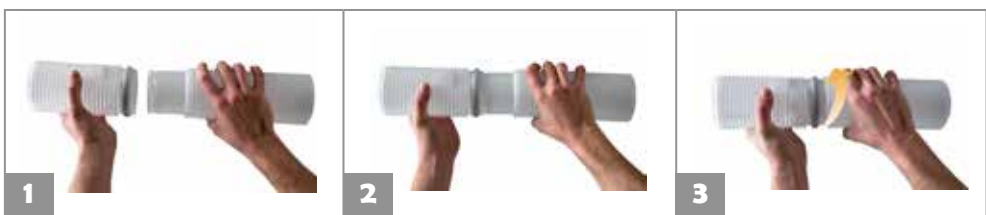

• Cada metro incluye 1 macho y 3 hembras (máximo aprovechamiento)

TUBOS			Ø60/100	Ø80/125
	<b>Tubo 200mm</b>	Ref.	60.810.200	60.811.200
		€		
		u/caja	6	6
	<b>Tubo 500mm</b>	Ref.	60.810.500	60.811.500
		€		
		u/caja	6	6
<b>Tubo 1000mm</b>	Ref.	60.810.000	60.811.000	
	€			
	u/caja	1	1	
<b>Tubo 2000mm</b>	Ref.	60.810.020	60.811.020	
	€			
	u/caja	6	6	



CODOS			Ø60/100	Ø80/125
	<b>Codo 45°</b>	Ref.	60.810.045	60.811.045
		€		
		u/caja	1	1
	<b>Codo 90°</b>	Ref.	60.810.090	60.811.090
		€		
		u/caja	1	1

ABRAZADERAS			Ø60/100	Ø80/125
	<b>Abrazadera fijación pared</b>	Ref.	92.192.002	92.194.002
		€		
		u/caja	6	6
	<b>Abrazadera pared circular</b>	Ref.	92.192.003	92.194.003
		€		
		u/caja	6	6

DEFLECTORES		Ø60/100	Ø80/125
<b>Deflector Condensación Coaxial</b>	Ref.	60.810.310	60.811.310
	€		
	u/caja	1	1



		Ø60/100	Ø80/125
<b>Tubo Deflector Horizontal M-M</b>	Ref.	60.810.300	60.811.300
	€		
	u/caja	1	1



		Ø60/100	Ø80/125
<b>Deflector Vertical Cubreaguas Negro (inclinación 20°/50°)</b>	Ref.	60.810.350	60.811.350
	€		
	u/caja	1	1





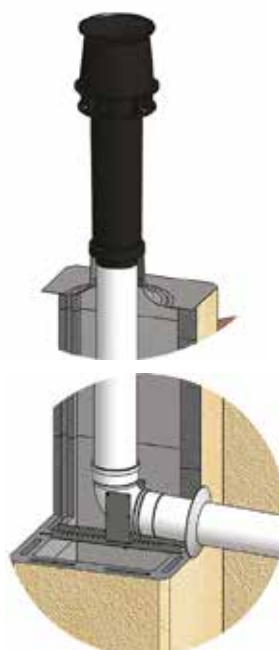

		Ø60/100	Ø80/125
<b>Deflector Vertical Negro 0,5 metros</b>	Ref.	60.810.400	60.811.400
	€		
	u/caja	1	1



### Salida a tejado

Ejemplo de instalación con salida vertical en sistema coaxial.

KIT CONDENSACIÓN COAXIAL M/H			Ø60/100
	<b>SIME - ITHALTERM - BALTUR - ARIFEL</b>	Ref.	60PACKIT1
		€	
	Compatibilidad	u/caja	1
	<b>ARISTON - BERETTA - CHAFFOTEAUX - YGNIS - ATLANTIC - ECOFLAM - RIELLO - IGNIS - VAILLANT - RHEMM RADI - SYLBER</b>	Ref.	60PACKIT2
		€	
	Compatibilidad	u/caja	1
	<b>ARGO - BAXI - REMEHA - VISSMANN - ROTEX - ROCA</b>	Ref.	60PACKIT3
		€	
	Compatibilidad	u/caja	1
	<b>BIASI - FERROLI - FONDITAL - LAMBORGHINI - NOVA - FLORIDA - SAVIO UNICAL - JOANNES</b>	Ref.	60PACKIT4
		€	
	Compatibilidad	u/caja	1
	<b>SAUNIER DUVAL - HERMANN - ATON</b>	Ref.	60PACKIT5
		€	
	Compatibilidad	u/caja	1
	<b>IMMERGAS</b>	Ref.	60PACKIT6
		€	
	Compatibilidad	u/caja	1
	<b>JUNKERS - BOSCH</b>	Ref.	60PACKIT7
		€	
	Compatibilidad	u/caja	1

Lacado en blanco RAL 9003 - Juntas incluidas

ADAPTADOR CONDENSACIÓN COAXIAL M/H			Ø60/100
	<b>Adaptador condensación coaxial M-H Ø60/100 A Ø80/125</b>	Ref.	60.610.825
		€	
		u/caja	1

SALIDA VERTICAL CONDENSACIÓN COAXIAL M/H		$\varnothing$ 60/100
	Ref.	60PACPV01
	€	
	u/caja	1
<b>Compatibilidad</b>		
	Ref.	60PACPV02
	€	
	u/caja	1
<b>Compatibilidad</b>		
	Ref.	60PACPV03
	€	
	u/caja	1
<b>Compatibilidad</b>		
	Ref.	60PACPV04
	€	
	u/caja	1
<b>Compatibilidad</b>		
	Ref.	60PACPV05
	€	
	u/caja	1
<b>Compatibilidad</b>		
	Ref.	60PACPV06
	€	
	u/caja	1
<b>Compatibilidad</b>		

Lacado en blanco RAL 9003 - Juntas incluidas

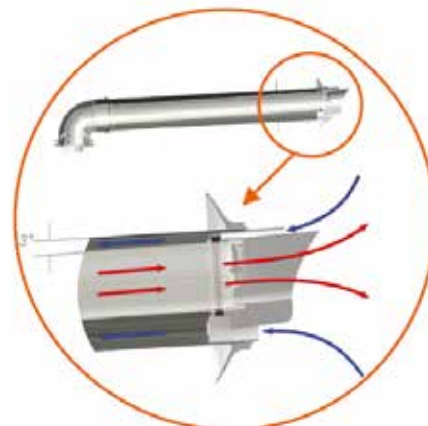
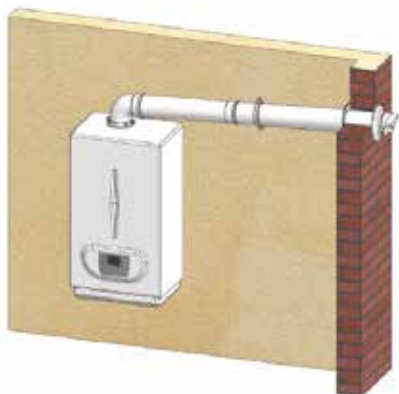

### Salida a pared

Ejemplo salida horizontal en muro.

**Gama**

# ALU-VAC

**Conductos para la evacuación de gases en aparatos atmosféricos y estancos en sistema biflujo**



EN 1856-2 T200 N1 W Vm L13100 O





## CARACTERÍSTICAS

- Fabricado en aluminio liso rígido con recubrimiento en blanco de esmalte de poliuretano
- Diámetros desde  $\varnothing 80\text{mm}$  a  $\varnothing 130\text{mm}$
- Estanqueidad mediante unión con junta de silicona (incluida en el precio)
- Sistema de unión: Macho-Macho
- Temperatura de trabajo:  $200^{\circ}\text{C}$  (intervalos a  $250^{\circ}\text{C}$ )

## APLICACIONES







## CERTIFICACIONES





- Productos conformes con las normativas RIGLO, RITE, UNE EN 1856-2, homologado CE y certificado
- Producto certificado por TÜV



TUBOS LISOS			$\varnothing$ 80	$\varnothing$ 100	$\varnothing$ 110	$\varnothing$ 125	$\varnothing$ 130
	<b>Tubo liso 200mm</b>	Ref.	92.191.200	92.192.200	92.193.200	92.194.200	92.195.200
		€					
		u/caja	6	6	6	6	6
	<b>Tubo liso 500mm</b>	Ref.	92.191.500	92.192.500	92.193.500	92.194.500	92.195.500
		€					
		u/caja	6	6	6	6	6
	<b>Tubo liso 1000mm</b>	Ref.	92.191.000	92.192.000	92.193.000	92.194.000	92.195.000
		€					
		u/caja	6	6	6	6	6
	<b>Tubo liso 1500mm</b>	Ref.	92.191.015	92.192.015	92.193.015	92.194.015	92.195.015
		€					
		u/caja	6	6	6	6	6
	<b>Tubo 200mm con toma de muestras</b>	Ref.		92.192.202	92.193.202	92.194.202	
		€					
		u/caja		6	6	6	

CODOS Y TES			$\varnothing$ 80	$\varnothing$ 100	$\varnothing$ 110	$\varnothing$ 125	$\varnothing$ 130
	<b>Codo 45°</b>	Ref.	92.191.045	92.192.045	92.193.045	92.194.045	92.195.045
		€					
		u/caja	6	6	6	6	6
	<b>Codo 90°</b>	Ref.	92.191.090	92.192.090	92.193.090	92.194.090	92.195.090
		€					
		u/caja	6	6	6	6	6

MÓDULOS FINALES			$\varnothing$ 80	$\varnothing$ 100	$\varnothing$ 110	$\varnothing$ 125	$\varnothing$ 130
	<b>Deflector 3 aros</b>	Ref.	92.191.010	92.192.010	92.193.010	92.194.010	92.195.010
		€					
		u/caja	6	6	6	6	6
	<b>Deflector antiretorno</b>	Ref.	92.191.011	92.192.011	92.193.011		92.195.011
		€					
		u/caja	6	6	6		6

ABRAZADERAS			$\varnothing$ 80	$\varnothing$ 100	$\varnothing$ 110	$\varnothing$ 125	$\varnothing$ 130
	<b>Abrazadera fijación pared regulable</b>	Ref.	92.191.002	92.192.002	92.193.002	92.194.002	92.195.002
		€					
		u/caja	6	6	6	6	6
	<b>Abrazadera fijación pared circular</b>	Ref.		92.192.003	92.193.003	92.194.003	92.195.003
		€					
		u/caja		6	6	6	6
	<b>Abrazadera fijación estática</b>	Ref.			93.341.003*		
		€					
		u/caja			6		

\* Disponible hasta agotar existencias; una vez liquidado el stock, la referencia quedará descatalogada.

ADAPTADORES			$\varnothing$ 80	$\varnothing$ 100	$\varnothing$ 110	$\varnothing$ 125	$\varnothing$ 130
	<b>Adaptador para ampliación</b>	Ref.	92.191.160	92.192.160	92.193.160	92.194.160	
		€					
		u/caja	6 $\varnothing$ 100	6 $\varnothing$ 110	6 $\varnothing$ 125	6 $\varnothing$ 130	
	<b>Adaptador caldera con toma muestras 200mm</b>	Ref.		92.192.161	92.193.161	92.194.161	
		€					
		u/caja		6 $\varnothing$ 103	6 $\varnothing$ 115	6 $\varnothing$ 128	
	<b>Manguito unión tubo con juntas</b>	Ref.	92.191.001	92.192.001	92.193.001	92.194.001	92.195.001
		€					
		u/caja	6	6	6	6	6

ACCESORIOS			$\varnothing$ 80	$\varnothing$ 100	$\varnothing$ 110	$\varnothing$ 125	$\varnothing$ 130
	<b>Embellecedor metálico</b>	Ref.	87.197.140P*	92.192.140	92.193.140	92.194.140	92.195.140
		€					
		u/caja	6	6	6	6	6
	<b>Junta silicona bilabial</b>	Ref.	92.191.180	92.192.180	92.193.180	92.194.180	92.195.180
		€					
		u/caja	6	6	6	6	6

\* Embellecedor  $\varnothing$ 80 fabricado en plástico

**Gama**

# ESTANCA COAXIAL

**Conductos de aluminio para la evacuación de gases  
en calderas estancas**



**EN 1856-2 T200 N1 W Vm L13100 O**  
**EN 1856-2 T200 P1 W Vm L13100 O**



## CARACTERÍSTICAS

- Fabricada en aluminio y chapa de acero laminada en frío con recubrimiento en esmalte poliuretano
- Sistema de unión Macho-Hembra
- Diámetros  $\varnothing 60-100\text{mm}$   
 $\varnothing 80-110\text{mm}$   
 $\varnothing 80-125\text{mm}$
- Temperatura de trabajo:  $200^{\circ}\text{C}$   
(intervalos a  $250^{\circ}\text{C}$ )

## APLICACIONES



## CERTIFICACIONES



- Productos conformes con las normativas RIGLO, RITE, UNE 1856-2, homologado CE y certificado
- Producto certificado por TÜV

TUBOS PROLONGADORES			Ø60/100	Ø80/110	Ø80/125
	<b>Tubo prolongador 250mm M/H</b>	Ref.	81.372.250	81.377.250	81.382.250
		€			
		u/caja	6	6	6
	<b>Tubo prolongador 500mm M/H</b>	Ref.	81.372.500	81.377.500	81.382.500
		€			
		u/caja	6	6	6
	<b>Tubo prolongador 1000mm M/H</b>	Ref.	81.372.000	81.377.000	81.382.000
		€			
		u/caja	1	1	1
	<b>Tubo prolongador 1500mm M/H</b>	Ref.	81.372.015	81.377.015	81.382.015
		€			
		u/caja	6	6	6

CODOS			Ø60/100	Ø80/110	Ø80/125
	<b>Codo Coaxial 45° M/H</b>	Ref.	81.373.045	81.378.045	81.383.045
		€			
		u/caja	1	1	1
	<b>Codo Coaxial 90° M/H</b>	Ref.	81.373.090	81.378.090	81.383.090
		€			
		u/caja	1	1	1

ADAPTADOR			Ø60/100	Ø80/110	Ø80/125
	<b>Adaptador para ampliación Ø60/100 a Ø80/125 M/H</b>	Ref.	81.372.160		
		€			
		u/caja	1		

MANGUITO			Ø60/100	Ø80/110	Ø80/125
	<b>Manguito Coaxial unión tubos H/H</b>	Ref.	64.370.001	64.375.001	64.380.001
		€			
		u/caja	6	6	6

TERMINAL			Ø60/100	Ø80/110	Ø80/125
	<b>Deflector Coaxial Aluminio</b>	Ref.	81.372.010	64.375.010	81.382.010
		€			
		u/caja	6	6	6

## Salida horizontal

Ejemplo de calentador estanco con salida coaxial a pared.

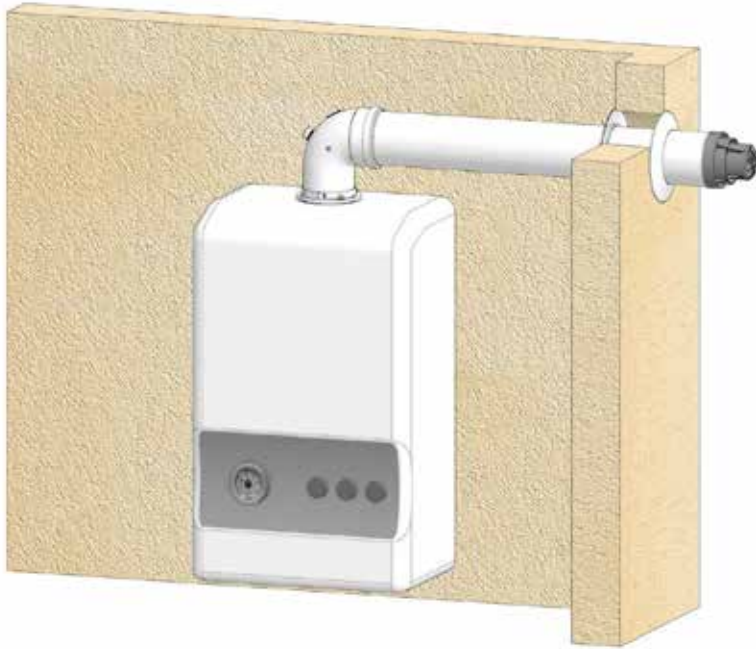

## Salida vertical

Ejemplo de calentador estanco con salida coaxial vertical a tejado.

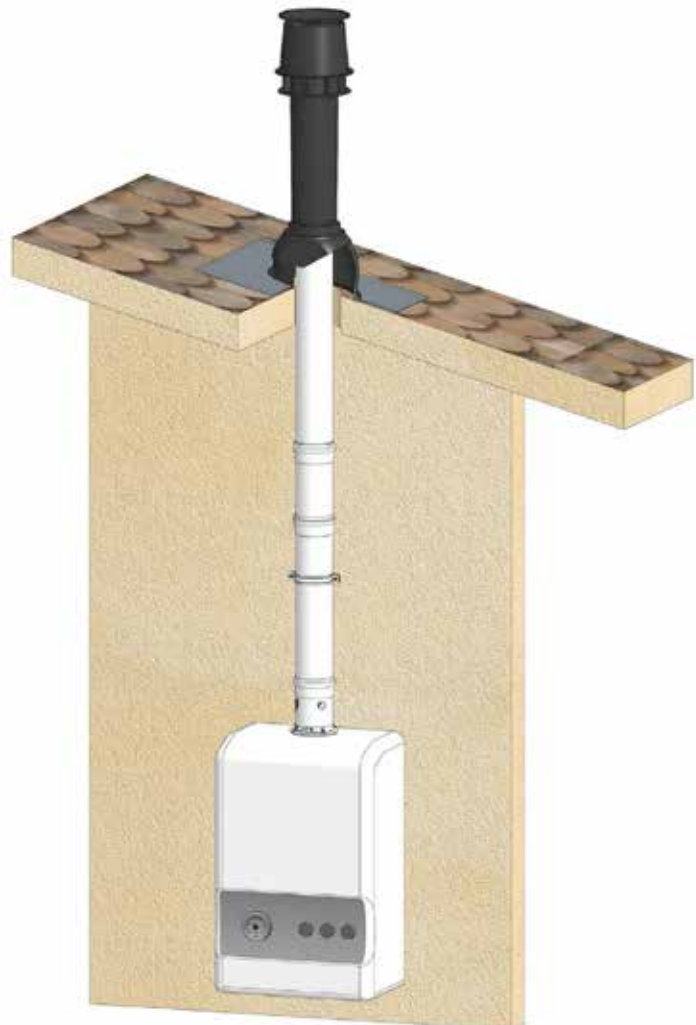

Gama

# VENTILACIÓN y AIREACIÓN

Sistemas de extracción de humos y gases en  
campanas extractoras y ventilación mecánica

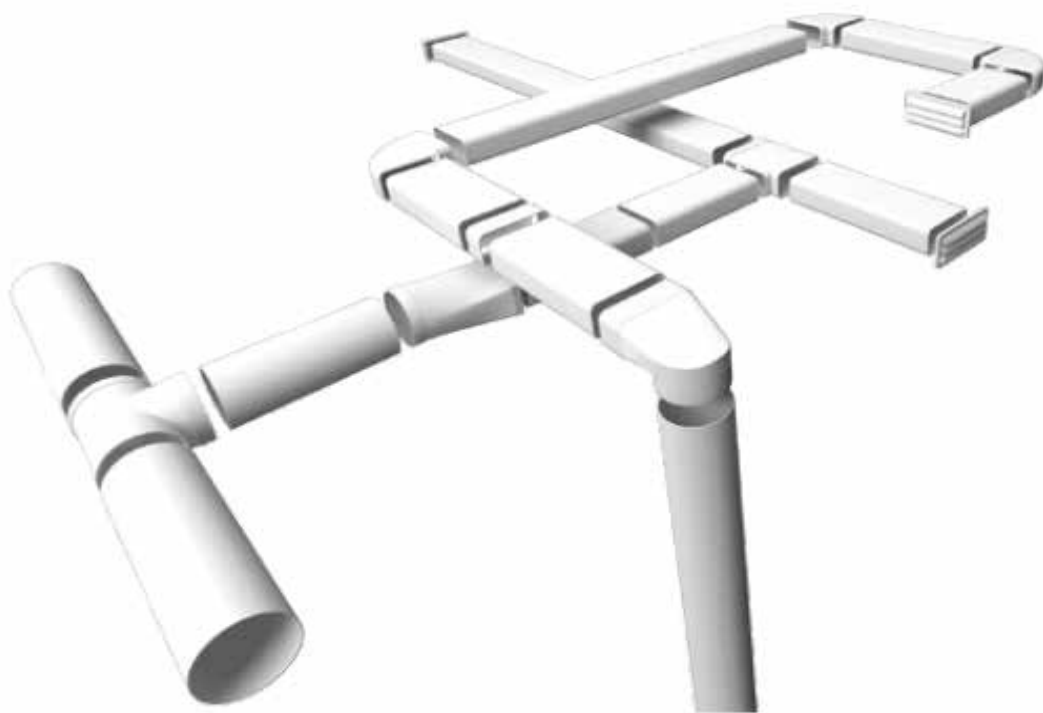

## CARACTERÍSTICAS

- Polipropileno plástico
- Diámetros  $\varnothing 100$  -  $\varnothing 120$  -  $\varnothing 150$
- Resistencia a temperaturas de hasta 90°C
- Aplicación: Extracción, campanas extractoras, ventilación y aerotermia



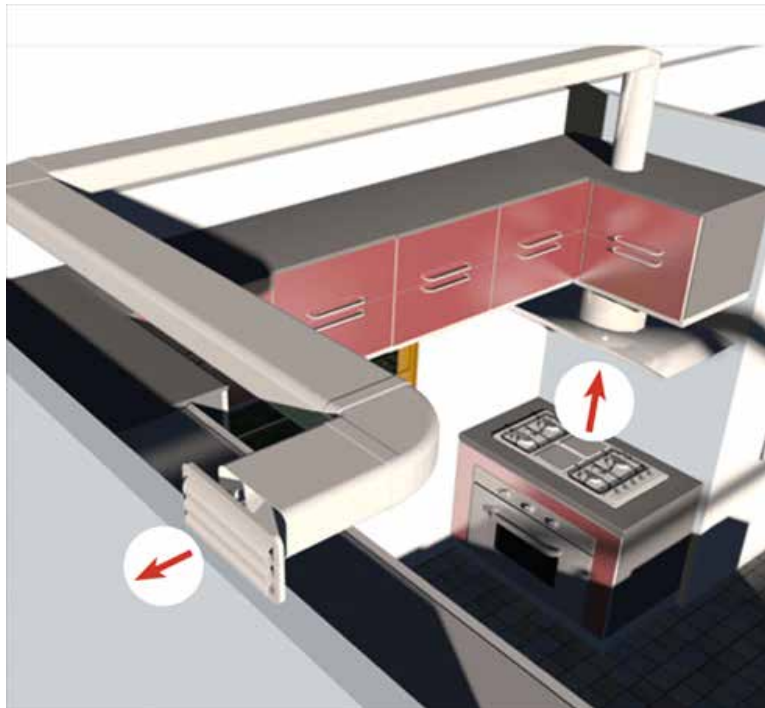

**Ignífugo y autoextinguible**

**Higiénico y antibacteriano**

**Alta estanqueidad**

**Atenuador acústico**

**Atérmico y dieléctrico**

**Anti-adherente**

## APLICACIONES



# VENTILACIÓN

Sistemas de extracción de humos y gases en campanas extractoras y ventilación mecánica



Ø100 - Ø120 - Ø150mm

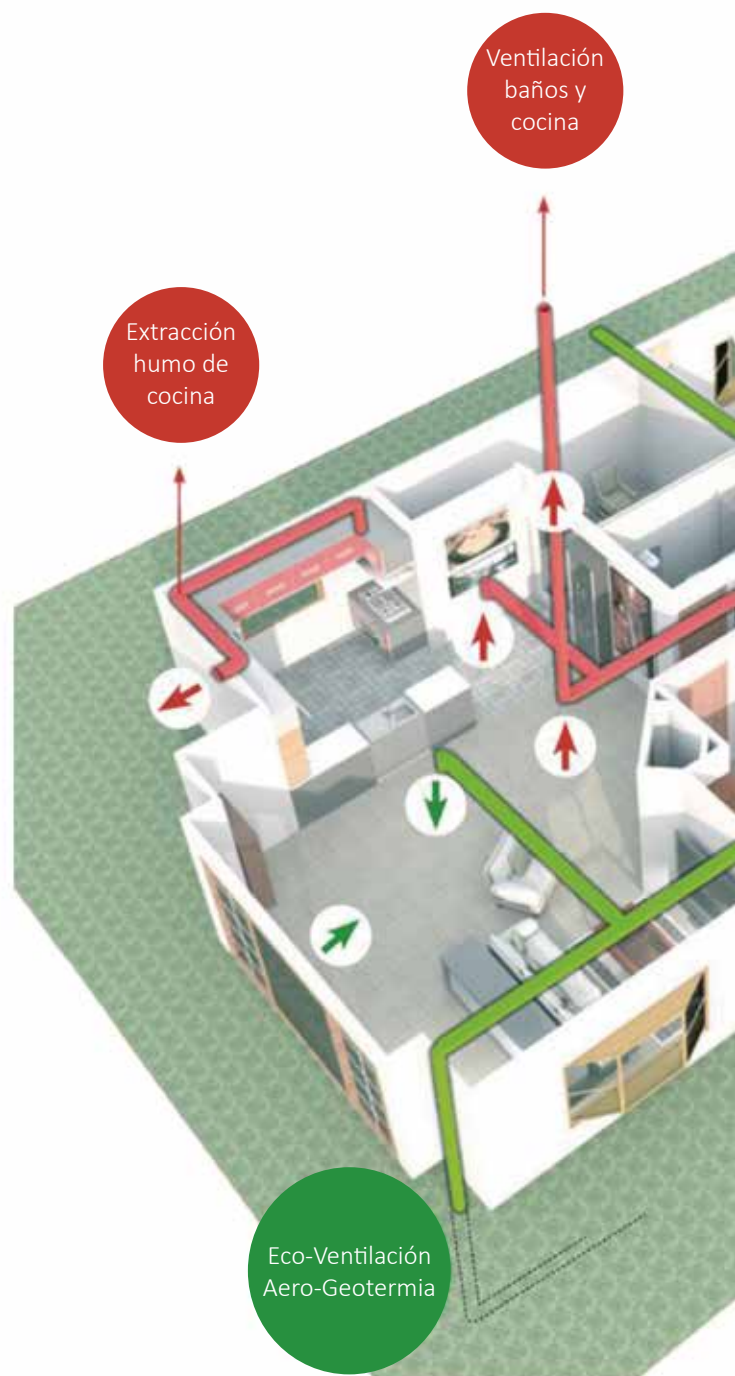









## Muestras de aplicaciones



- Sistema de extracción de humos en cocinas
- Ventilación de baño, aseos y zonas húmedas
- Ventilación terciaria de locales y oficinas
- Eco-Ventilación y Geo-Ventilación
- Ventilación natural, híbrida y mecánica

**NOVEDADES EN REFERENCIAS DE LA GAMA Ø100**

TUBOS			Ø100 110 X 55 mm	Ø120 147 X 70 mm	Ø150 170 X 90 mm
	<b>Tubo rectangular 1,5 metros</b>	Ref.	63.100.200	63.120.000	63.130.000
		€			
		u/caja	16	12	8
	<b>Tubo redondo 1,5 metros</b>	Ref.	63.100.201	63.120.101	63.130.101
		€			
		u/caja	12	8	8

CODOS			Ø100 110 X 55 mm	Ø120 147 X 70 mm	Ø150 170 X 90 mm
	<b>Codo 90° redondo</b>	Ref.	63.100.206	63.120.106	63.130.106
		€			
		u/caja	45	30	15
	<b>Codo 90° mixto</b>	Ref.	63.100.207	63.120.107	63.130.107
		€			
		u/caja	60	30	15
	<b>Codo 90° rectangular horizontal</b>	Ref.	63.100.209	63.120.109	63.130.109
		€			
		u/caja	105	30	15
	<b>Codo 90° rectangular vertical</b>	Ref.	63.100.208	63.120.108	63.130.108
		€			
		u/caja	72	30	15
	<b>Codo 45° redondo</b>	Ref.	63.100.223	63.120.123	
		€			
		u/caja	50	30	
	<b>Codo 45° rectangular horizontal</b>	Ref.	63.100.218	63.120.118	63.130.118
		€			
		u/caja	50	30	15

**NOVEDAD**

TES			Ø100 110 X 55 mm			
	<b>Te 3 bocas redonda</b>	Ref.	63.100.219	63.100.220	Ref.	<b>Te mixta rectangular vertical</b> 
		€			€	
		u/caja	25	50	u/caja	

**NOVEDADES EN REFERENCIAS DE LA GAMA Ø100**

EMPALMES			Ø100 110 X 55 mm	Ø120 147 X 70 mm	Ø150 170 X 90 mm
	<b>Empalme rectangular</b>	Ref.	63.100.204	63.120.104	63.130.104
		€			
		u/caja	60	30	15
	<b>Empalme redondo</b>	Ref.	63.0100.202	63.120.102	63.130.102
		€			
		u/caja	60	30	15
	<b>Empalme pared mixto</b>	Ref.	63.100.212		
		€			
		u/caja	80		
	<b>Empalme mixto</b>	Ref.	63.100.205	63.120.105	63.130.105
		€			
		u/caja	45	30	15
	<b>Empalme pared redondo</b>	Ref.	63.100.221	63.120.121	
		€			
		u/caja	50	30	
	<b>Empalme pared rectangular</b>	Ref.	63.100.222	63.120.122	
		€			
		u/caja	50	30	

ABRAZADERAS			Ø100 110 X 55 mm	Ø120 147 X 70 mm	Ø150 170 X 90 mm
	<b>Abrazadera fijación pared rectangular horizontal metálica</b>	Ref.	63.100.216		
		€			
		u/caja	50		
	<b>Abrazadera fijación pared rectangular vertical metálica</b>	Ref.	80.000.114		
		€			
		u/caja	50		
	<b>Abrazadera fijación pared redonda metálica</b>	Ref.	92.192.003		
		€			
		u/caja	6		
	<b>Abrazadera redonda PVC</b>	Ref.	63.100.215	63.120.115	
		€			
		u/caja	50	30	
	<b>Abrazadera rectangular plana PVC</b>	Ref.		63.120.116	
		€			
		u/caja		30	

**NOVEDADES EN REFERENCIAS DE LA GAMA Ø100**

ADAPTADORES CAMPANA						
	<b>Adaptador campana salida Ø96 Ø100 Ø116 Ø120 Ø124</b>	Ref.	63.100.203	<b>Adaptador campana Ø125 a Ø120</b>	Ref.	63.120.125
		€			€	
		u/caja	60		u/caja	30
	<b>Adaptador campana salida Ø125 a Ø100</b>	Ref.	63.120.103	<b>Adaptador campana Ø150 a Ø120</b>	Ref.	63.120.154
		€			€	
		u/caja	30		u/caja	30

EMBELLECEDORES			Ø100 110 X 55 mm	Ø120 147 X 70 mm	Ø150 170 X 90 mm
	<b>Embellecedor pared redondo</b>	Ref.	63.100.213	63.120.113	
		€			
		u/caja	50	30	
	<b>Embellecedor pared rectangular</b>	Ref.	63.100.214	63.120.114	
		€			
		u/caja	50	30	

VENTANAS REJILLAS			Ø100 110 X 55 mm	Ø120 147 X 70 mm	Ø150 170 X 90 mm
	<b>Ventana rejilla exterior redonda</b>	Ref.	63.100.224	63.120.124	
		€			
		u/caja	50	30	
	<b>Ventana rejilla exterior rectangular</b>	Ref.	63.100.226	63.120.126	
		€			
		u/caja	50	30	
	<b>Ventanilla salida exterior redonda mixta</b>	Ref.	63.100.210	63.120.110	
		€			
		u/caja	30	30	
	<b>Ventanilla salida exterior rectangular</b>	Ref.	63.100.211	63.120.111	
		€			
		u/caja	30	30	
	<b>Ventanilla mixta (antiretorno)</b>	Ref.			63.130.110
		€			
		u/caja			15
	<b>Ventanilla mixta marrón (antiretorno)</b>	Ref.			63.130.150
		€			
		u/caja			15
	<b>Ventana rejilla exterior rectangular marrón</b>	Ref.		63.120.152	
		€			
	<b>Ventana rejilla exterior redonda marrón</b>	Ref.		63.120.153	
		€			

**REJILLAS** para la ventilación de humos y aire de locales domésticos, comerciales e industriales. La línea aireación se presenta en material de **aluminio y chapa de acero con/sin esmaltado en blanco**. Montaje sencillo y eficaz.

REJILLAS	Paso de aire cm <sup>2</sup>	Aluminio	Blanco	
	225 cm <sup>2</sup>	88.130.109	88.132.109	Ref.
				€
		100	100	u/caja
	60 cm <sup>2</sup>	88.130.101	88.132.101	Ref.
				€
		100	100	u/caja
	150 cm <sup>2</sup>	88.130.102	88.132.102	Ref.
				€
		100	100	u/caja
	95 cm <sup>2</sup>	88.130.103	88.132.103	Ref.
				€
		100	100	u/caja
	240 cm <sup>2</sup>	88.130.111	88.132.111	Ref.
				€
		100	100	u/caja
	160 cm <sup>2</sup>	88.130.104	88.132.104	Ref.
				€
		100	100	u/caja
	80 cm <sup>2</sup>	88.130.113	88.132.114	Ref.
				€
		100	100	u/caja
	75 cm <sup>2</sup>	88.130.110	88.132.110	Ref.
				€
		100	100	u/caja

**Material disponible en stock y en cualquier cantidad**

	PVP	u/caja		PVP	u/caja
Rejilla 100x100 Aluminio Madera		200	Rejilla 170x170 Aluminio Blanco con Mosquitera		25
Rejilla 100x200 Aluminio Madera		200	Rejilla 170x170 Aluminio Madera con Mosquitera		25
Rejilla 200x100 Aluminio Madera		200	Rejilla 200x200 Aluminio Madera		100
Rejilla 150x150 Aluminio Madera		250	Rejilla 200x200 Aluminio con Mosquitera		25
Rejilla 150x150 Aluminio con Mosquitera		25	Rejilla 200x200 Esmaltada con Mosquitera		25
Rejilla 150x150 Esmaltada con Mosquitera		25	Rejilla 200x200 Aluminio Blanco con Mosquitera		25
Rejilla 150x150 Aluminio Blanco con Mosquitera		25	Rejilla 200x200 Aluminio Madera con Mosquitera		25
Rejilla 150x150 Aluminio Madera con Mosquitera		25	Rejilla 200x200 Empotrar Aluminio		80
Rejilla 160x160 Empotrar Aluminio		100	Rejilla 200x200 Empotrar Aluminio Blanco		80
Rejilla 160x160 Empotrar Aluminio Blanco		100	Rejilla 200x200 Empotrar Aluminio Madera		80
Rejilla 160x160 Empotrar Aluminio Madera		100	Rejilla 300x150 Aluminio Madera		150
Rejilla 170x170 Aluminio Madera		100	Rejilla 120x240 Empotrar Aluminio		80
Rejilla 170x170 Aluminio con Mosquitera		25	Rejilla 120x240 Empotrar Aluminio Blanco		80

**Material disponible bajo pedido y en cajas completas**

# Condiciones Generales



Estas condiciones corresponden a la presente Tarifa que sustituye y anula todas las anteriores. VACUFLEX se reserva el derecho a introducir modificaciones sin previo aviso, sobre todo en este último periodo de inestabilidad en el mercado de las materias primas.

- Pedido mínimo: 100€
- Portes: se suministrarán a portes pagados los envíos superiores a 400€ de venta neta.
- Devoluciones: en ningún caso se aceptarán devoluciones de material sin la previa autorización de VACUFLEX.
- Reclamaciones: las reclamaciones por incidencias en la recepción de material (diferencias en cantidad o averías) tienen un plazo de reclamación de 48h.
- Uso indebido: cualquier utilización o uso de nuestros productos para fines diferentes a los que fueron fabricados exime a VACUFLEX de cualquier tipo de reclamación o responsabilidad.



Empresa certificada ISO 9001:2015



# Certificaciones



# Notas





# VACUFLEX



C/ Guifré el Pilòs, 3 – P.I. Can Vinyals  
08130 – Santa Perpètua de Mogoda (Barcelona)

Tel. 93 464 32 33 – Fax 93 464 36 37

[info@vacuflex.es](mailto:info@vacuflex.es)

[www.vacuflex.es](http://www.vacuflex.es)